

描述 / Descriptions

TO-3P 塑封封装绝缘栅双极晶体管。Insulated-Gate Bipolar Transistor in a TO-3P Plastic Package.

特征 / Features

内置快恢复二极管, 饱和压降为正温度系数, 高可靠性及热稳定性, 良好的参数一致性, RoHS 产品。
Built in fast recovery diode, Saturation voltage positive temperature coefficient, High reliability and thermal stability parameters, good agreement, RoHS product.

用途 / Applications

逆变器, 变频器, 不间断电源。
General purpose inverter, Frequency converters, Uninterrupted Power Supply(UPS).

内部等效电路 / Equivalent Circuit

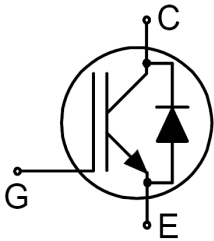

引脚排列 / Pinning

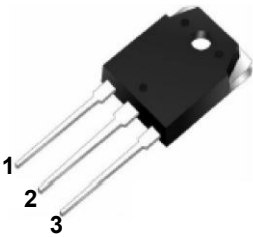

PIN1 : Gate PIN 2 : Collector PIN 3 : Emitter

放大及印章代码 / h_{FE} Classifications & Marking

见印章说明。See Marking Instructions.

极限参数 / Absolute Maximum Ratings(Ta=25°C)

| 参数 Parameter | 符号 Symbol | 数值 Rating | 单位 Unit |
|--|----------------|--------------|------------|
| Collector-emitter voltage | V_{CES} | 650 | V |
| Gate-emitter voltage | V_{GES} | ±20 | V |
| Collector current@ $T_C=25^\circ\text{C}$ | I_C | 120 | A |
| Collector current@ $T_C=100^\circ\text{C}$ | | 60 | A |
| Collector peak current, T_P limited by T_{JMAX} | I_{CM} | 180 | A |
| Diode forward current@ $T_C=100^\circ\text{C}$ | I_F | 30 | A |
| Diode maximum forward current | I_{FM} | 60 | A |
| Power dissipation($T_C=25^\circ\text{C}$) | P_D | 310 | W |
| Power dissipation($T_C=100^\circ\text{C}$) | | 125 | W |
| Operating junction and storage temperature range | T_J, T_{stg} | -55~155 | °C |
| Maximum temperature for soldering | T_L | 260 | °C |
| IGBT thermal resistance,junction-case | $R_{th(j-c)}$ | 0.4 | °C/W |
| Diode thermal resistance,junction-case | $R_{th(j-c)}$ | 1.2 | °C/W |
| Thermal resistance,junction-ambient | $R_{th(j-a)}$ | 40 | °C/W |

电性能参数 / Electrical Characteristics(Ta=25°C)

| 参数 Parameter | 符号 Symbol | 测试条件 Test Conditions | 最小值 Min | 典型值 Typ | 最大值 Max | 单位 Unit |
|--------------------------------------|---------------|--------------------------------------|------------|------------|------------|------------|
| Collector-emitter breakdown voltage | V_{CES} | $V_{GE}=0V$ $I_{CE}=1.0mA$ | 650 | - | - | V |
| Zero gate voltage Collector current | I_{CES} | $V_{GE}=0V$ $V_{CE}=650V$ | - | - | 4 | µA |
| Gate-body leakage current | I_{GES} | $V_{GE}=\pm 20V$ $V_{CE}=0V$ | - | - | ±100 | nA |
| Gate threshold voltage | $V_{GE(th)}$ | $I_C=0.8mA$ $V_{CE}=V_{GE}$ | 5.3 | 5.7 | 6.3 | V |
| Collector-emitter saturation voltage | $V_{CE(sat)}$ | $I_C=60A$ $V_{GE}=15V$ | - | 2.2 | - | V |
| Input capacitance | C_{ies} | $V_{CE}=25V$ $V_{GE}=0V$ $f=1MHz$ | - | 5150 | - | pF |
| Output capacitance | C_{oes} | | - | 300 | - | |
| Reverse transfer capacitance | C_{res} | | - | 65 | - | |

电性能参数 / Electrical Characteristics(Ta=25°C)

| 参数 Parameter | 符号 Symbol | 测试条件 Test Conditions | 最小值 Min | 典型值 Typ | 最大值 Max | 单位 Unit |
|-------------------------------------|--------------|--|------------|------------|------------|------------|
| Input capacitance | C_{ies} | $V_{CE}=25V$ $V_{GE}=0V$ $f=1MHz$ | - | 5150 | - | pF |
| Output capacitance | C_{oes} | | - | 300 | - | |
| Reverse transfer capacitance | C_{res} | | - | 65 | - | |
| Turn-on delay time | $t_{d(ON)}$ | $V_{CE}=400V$ $I_C=60A,$ $R_G=3\Omega$ $V_{GE}=0/15V$ Inductive Load | - | 35 | - | ns |
| Rise time | t_r | | - | 35 | - | |
| Turn-off delay time | $t_{d(OFF)}$ | | - | 107 | - | |
| Fall time | t_f | | - | 36 | - | |
| Turn-On Switching Loss | E_{on} | | - | 2.05 | | mJ |
| Turn-Off Switching Loss | E_{off} | | - | 1.11 | | |
| Total Switching Loss | E_{ts} | | - | 3.16 | | |
| Total gate charge | Q_G | $V_{CE}=480V$ $I_C=60A$ $V_{GE}=15V$ | - | 135 | - | nC |
| Diode forward voltage | V_F | $I_F=60A$ | - | 2.54 | | V |
| Reverse recovery time | T_{rr} | $VR=400V$ $I_F=30A$ $di/dt=500A/\mu S$ | - | 60 | | ns |
| Diode Peak Reverse Recovery Current | I_{rr} | | - | 12 | | A |
| Reverse recovery charge | Q_{rr} | | - | 0.4 | | uC |

电参数曲线图 / Electrical Characteristic Curve

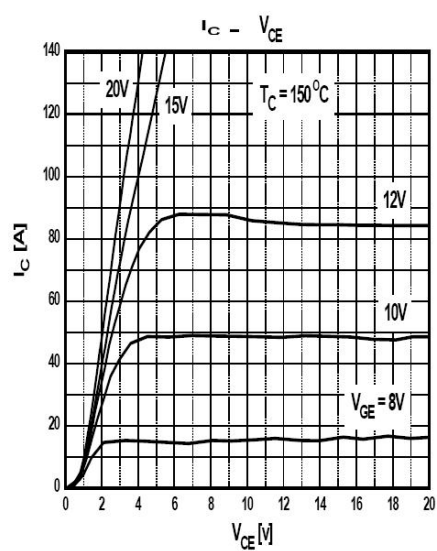
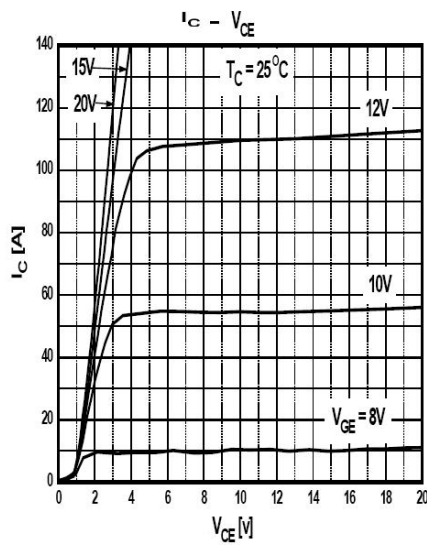
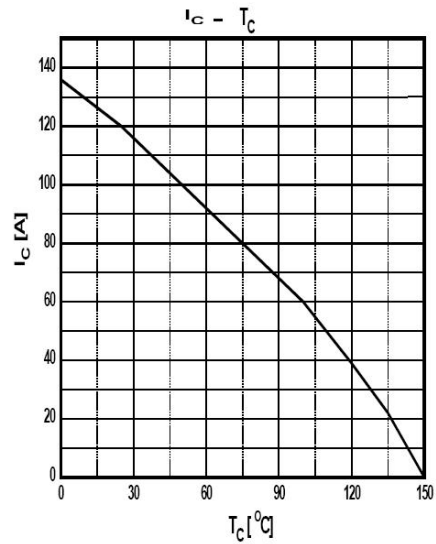
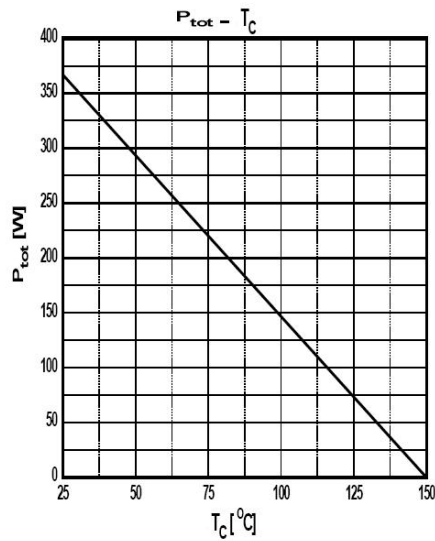
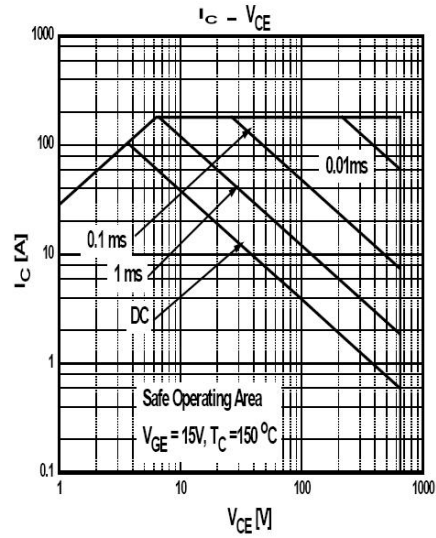
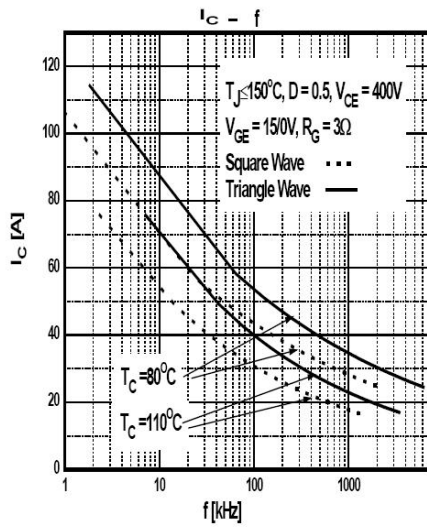

电参数曲线图 / Electrical Characteristic Curve

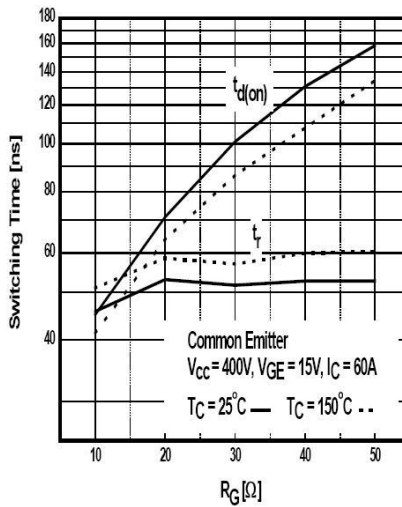
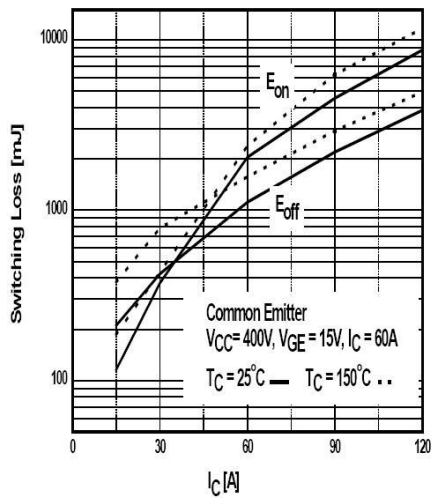
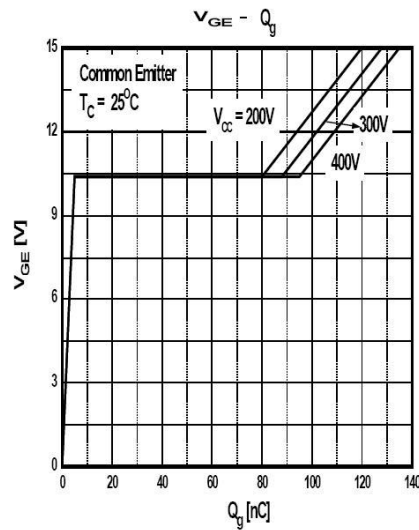
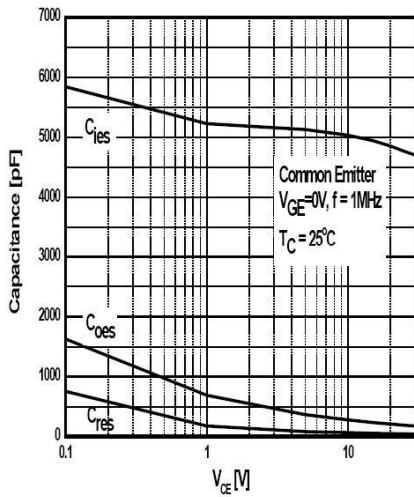
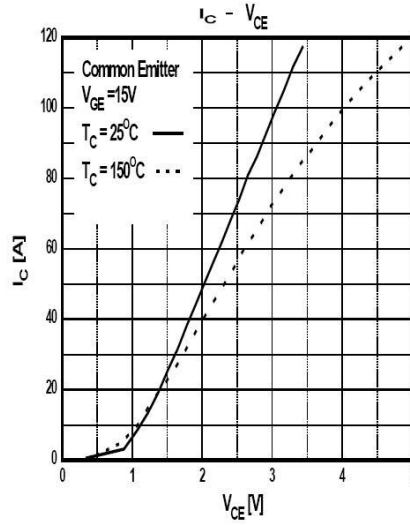
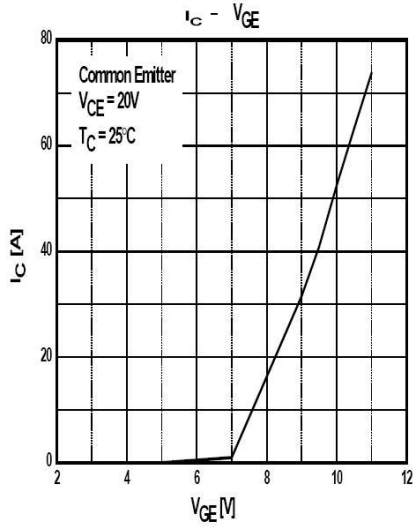

电参数曲线图 / Electrical Characteristic Curve

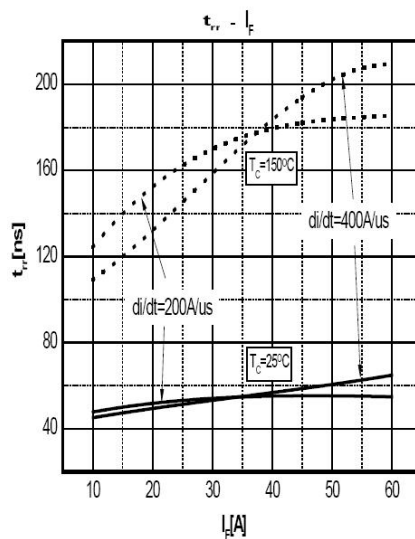
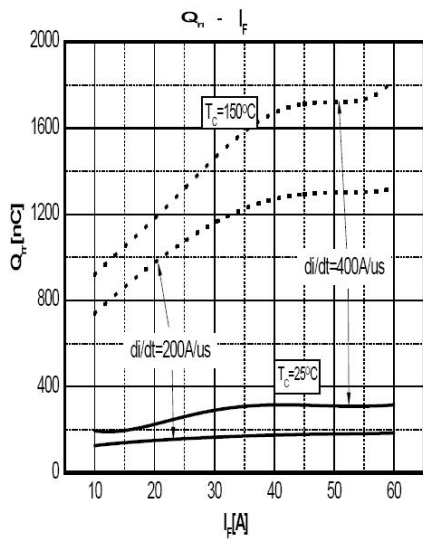
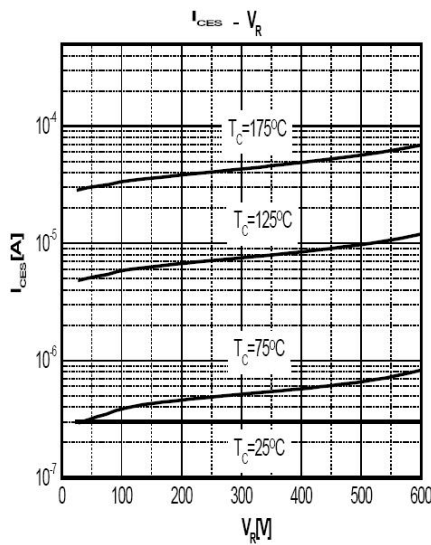
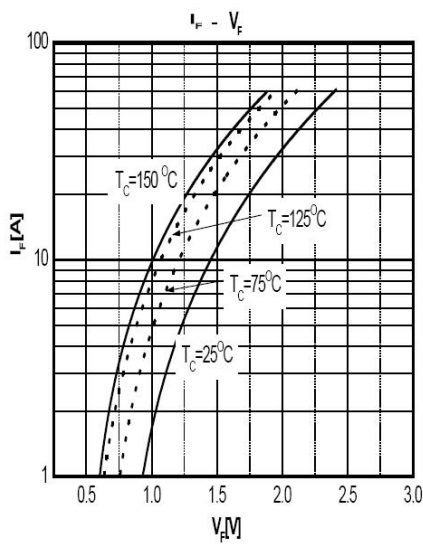
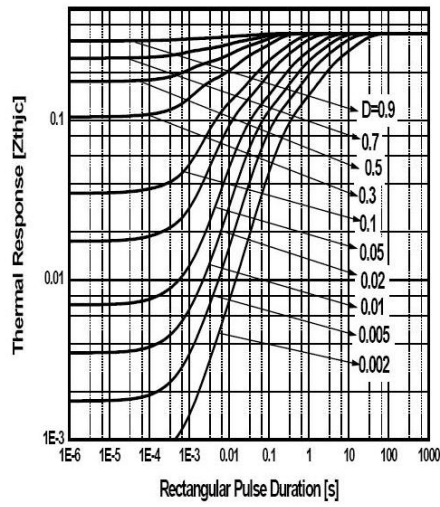
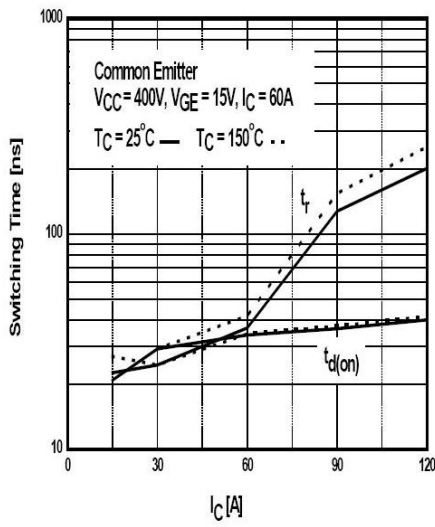

波形图 / Wave curve

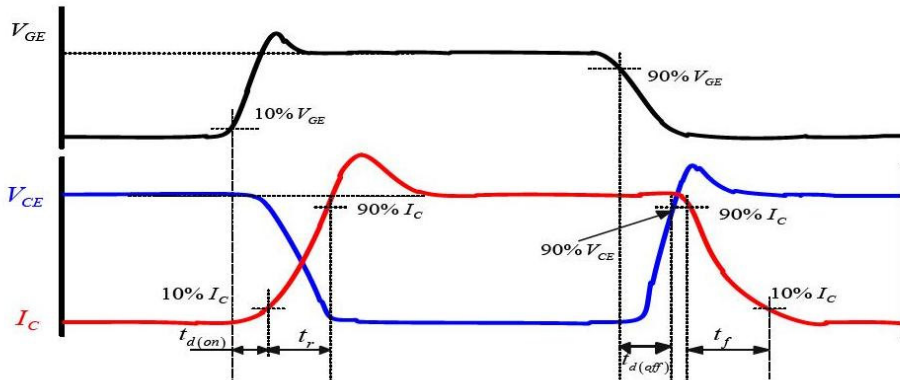

Figure A. Definition of switching times

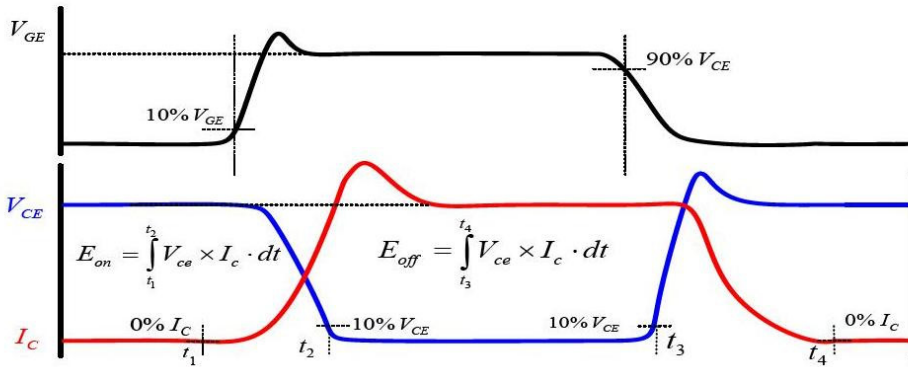

Figure B. Definition of switching losses

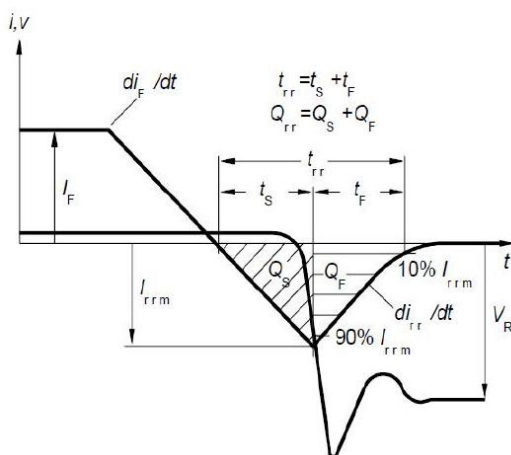

Figure C. Definition of diodes switching characteristics

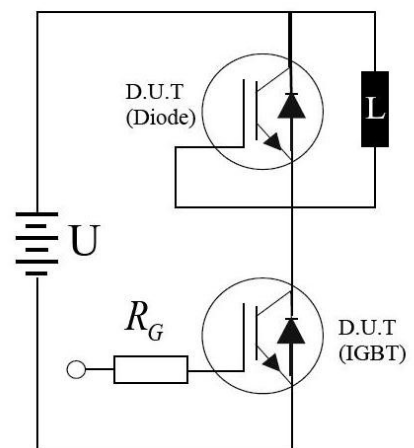
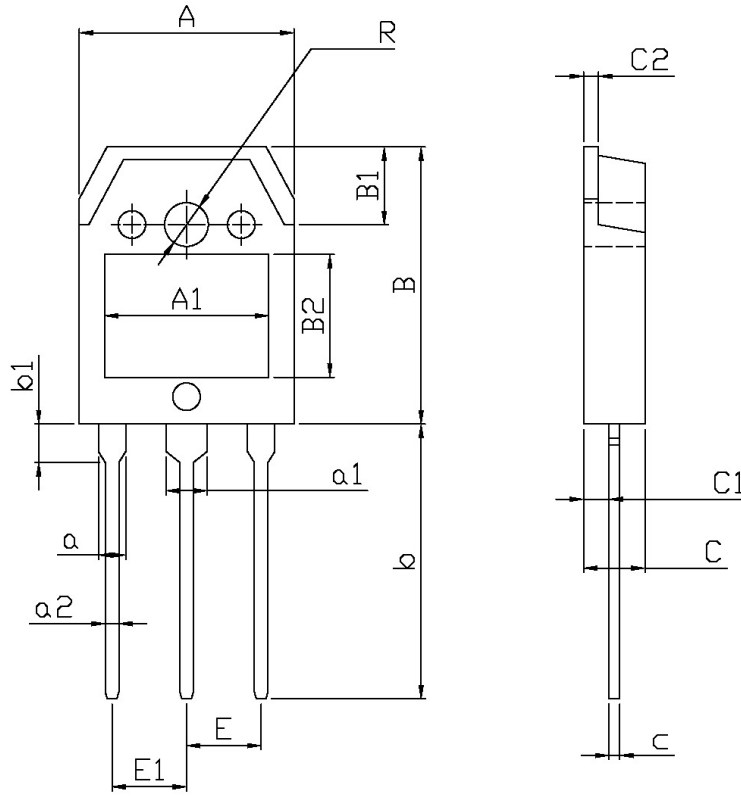

Figure D. Dynamic test circuit

外形尺寸图 / Package Dimensions

TO-3P

单位: mm



| Symbol | Dimensions In Millimeters | | Symbol | Dimensions In Millimeters | |
|--------|---------------------------|------|--------|---------------------------|-----|
| | Min | Max | | Min | Max |
| A | 15.4 | 16.0 | a2 | 0.8 | 1.2 |
| R | 3.1 | 3.5 | E | 5.45 | |
| B | 19.8 | 20.8 | E1 | 5.45 | |
| B1 | 5.5 | 5.9 | C | 4.3 | 4.7 |
| B2 | 9.0 | | C1 | 1.2 | 1.6 |
| A1 | 12.0 | | C2 | 1.4 | 1.6 |
| b | 19.6 | 20.6 | c | 0.5 | 0.7 |
| b1 | 3.0 | 3.4 | | | |
| a | 1.8 | 2.2 | | | |
| a1 | 2.8 | 3.2 | | | |

印章说明 / Marking Instructions

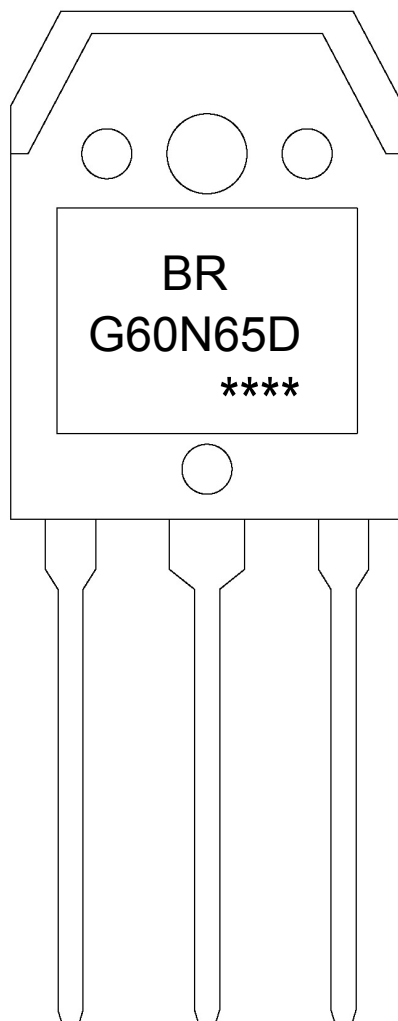

说明：

BR: 为公司代码

G60N65D： 为产品型号

****： 为生产批号代码，随生产批号变化。

Note:

BR: Company Code.

G60N65D: Product Type.

****: Lot No. Code, code change with Lot No.

波峰焊温度曲线图(无铅) / Temperature Profile for Dip Soldering(Pb-Free)

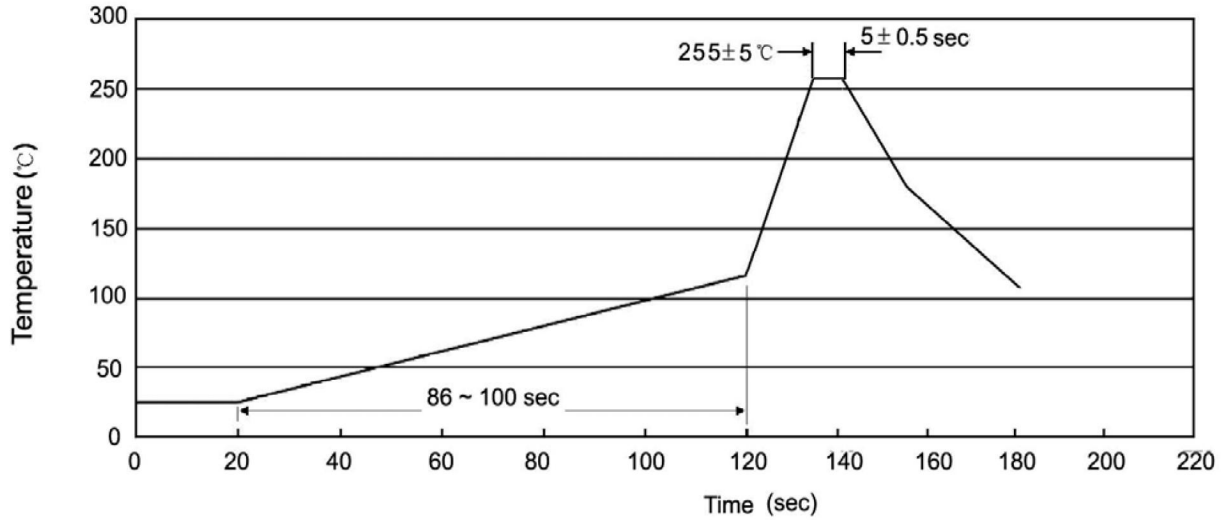

说明：

- 1、预热温度 25~150°C，时间 60~90sec;
- 2、峰值温度 255±5°C，时间持续为 5±0.5sec;
- 3、焊接制程冷却速度为 2~10°C/sec.

Note:

- 1.Preheating:25~150°C, Time:60~90sec.
- 2.Peak Temp.:255±5°C, Duration:5±0.5sec.
3. Cooling Speed: 2~10°C/sec.

耐焊接热试验条件 / Resistance to Soldering Heat Test Conditions

温度：270±5°C 时间：10±1 sec. Temp.:270±5°C Time:10±1 sec

包装规格 / Packaging SPEC.

套管包装 / TUBE

| Package Type 封装形式 | Units 包装数量 | | | | | Dimension 包装尺寸 (unit: mm ³) | | |
|----------------------|--------------------|-------------------------|------------------------|------------------------------|------------------------|---|-------------|-------------|
| | Units/Tube 只/套管 | Tubes/Inner Box 套管/盒 | Units/Inner Box 只/盒 | Inner Boxes/Outer Box 盒/箱 | Units/Outer Box 只/箱 | Tube 套管 | Inner Box 盒 | Outer Box 箱 |
| TO-3P | 30 | 15 | 450 | 5 | 2250 | 497.5×46×8 | 555×164×50 | 575×290×180 |

使用说明 / Notices